

 STANDARD SYSTEM

 DESIGN SYSTEM

 DOUBLEDECK

 TRUSS

 WALL SYSTEM

 FLOOR SYSTEM

 FABRIC SYSTEM

 SHOWCASES

 EXPO FURNITURE

 EXPO ELECTRICAL EQUIPMENT

 ASSISTANT MATERIAL

 PACKING



DOUBLE DECK



Bring Eco-friendly Display System into every show space.

Address: No. 63, Linjin Road, Yaoguan, Changzhou, Jiangsu, 213102, China
Post code: 213102
Tel: 0086-519-88702888 88702558 88702568
Fax: 0086-519-88701653
Email: lintong@ling-tong.cn
<http://www.ling-tong.com>
Toll free: **800-828-6786**

LINGTONG Double Deck

Double Deck

LT-DFT350

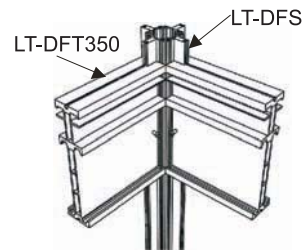
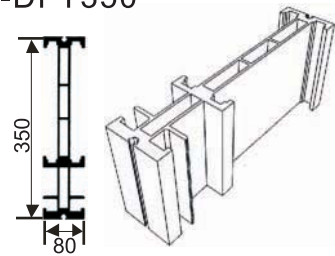

LT-DFT350 is the supporting beam of double deck. It is mainly used around the second floor and its max length can reach 6 meters.

LT-DFT250

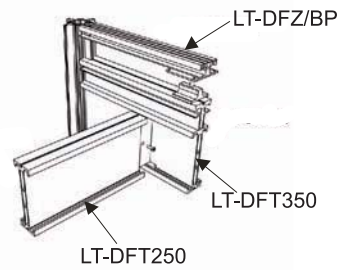
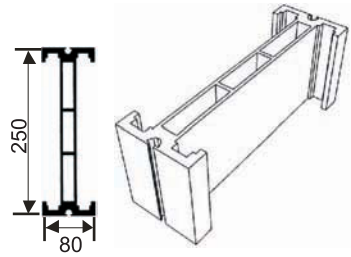

1.LT-DFT250 is the coupling beam of double deck.It is mainly used as the frame beam of the second floor. Its both ends and the supporting beam are connected by LT-DFT1000.The max length can reach 6 meters.
2.LT-DFT250 can be also applied to the bearing beam for stairs.

LT-DFS

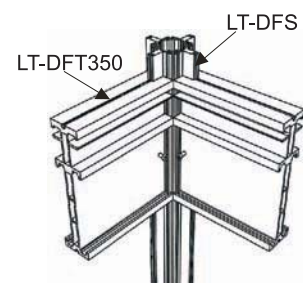
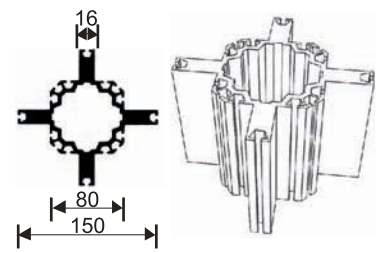

LT-DFS is a cross upright extrusion and used as the supporting structure of double deck.

LT-DFZ/BP

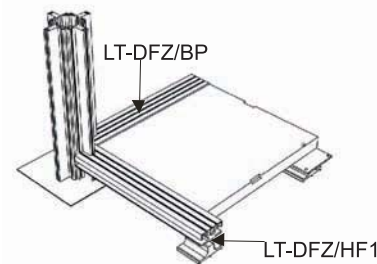
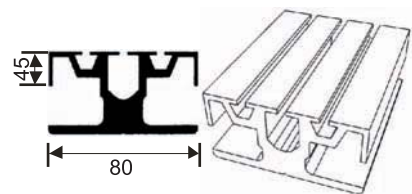

LT-DFZ/BP is a floor extrusion which is applied to fixing floor.

LT-DFZ45

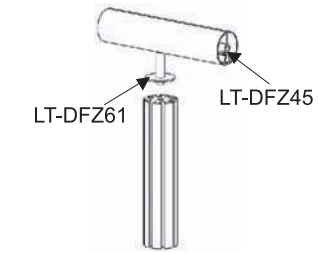
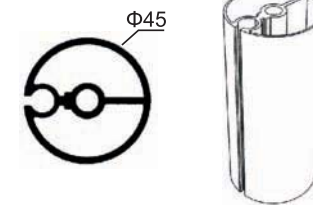

LT-DFZ45 is a banister extrusion.

LT-DFZ22

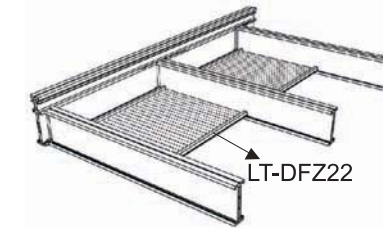
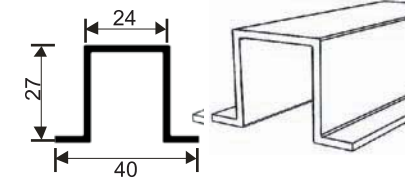

LT-DFZ22 is a ceiling gird profile. It is installed on the coupling beam to form the ceiling.

LT-S408

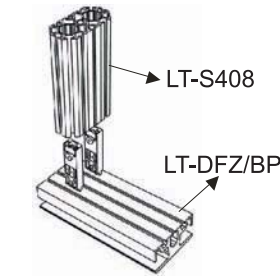
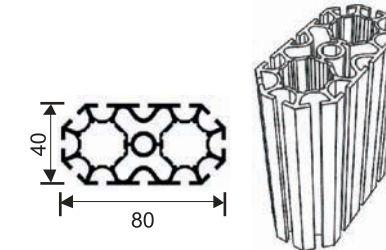

LT-S408 is a kind of upright extrusion with two holes. It is usually used as the cover upright extrusion of the second floor.

LT-DFS/IV-01

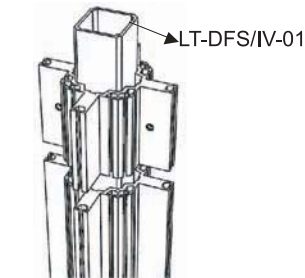
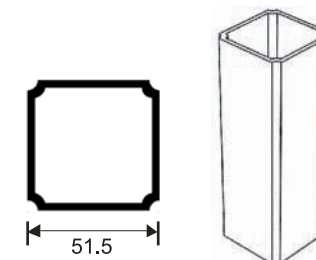

LT-DFS/IV-01 is the connector of upright extrusions, which can connect two cross profiles.

LINGTONG Double Deck

Double Deck

Double Deck

LT-DFZ/V9-1

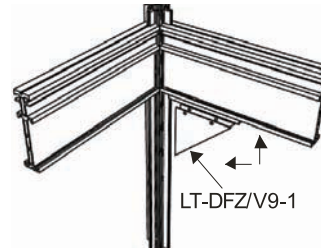
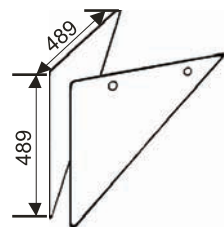

LT-DFZ/V9-1 is angle reinforcement. It connects the supporting beam with the upright extrusion to enhance the stability of double deck.

LT-DFT1000

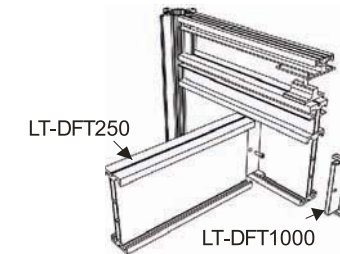
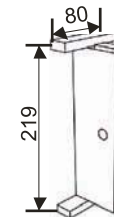

LT-DFT1000 is a beam connector which connects the coupling beam with the supporting beam at 90°.

LT-DFT1045

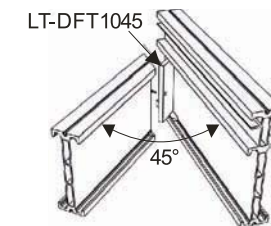
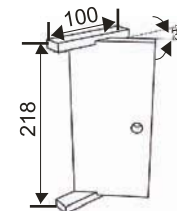

LT-DFT1045 is a beam connector which connects the coupling beam with the supporting beam at 45°.

LT-DFZ91A-3J

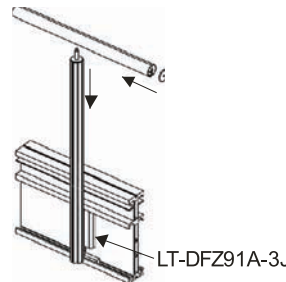
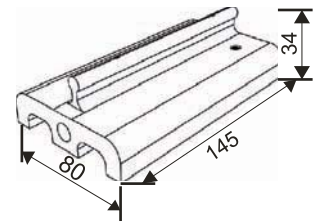

LT-DFZ91A-3J is a connecting bracket base and used to fix the coupling beam with the handrail upright extrusion together.

LT-DFZ20

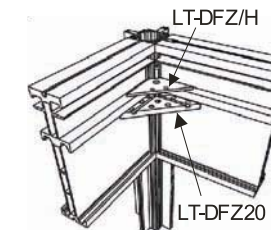
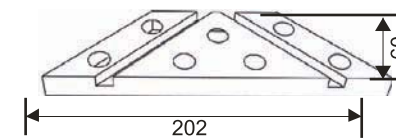

LT-DFZ20 is a kind of cantilever damping device. It reinforces the Double Deck in the horizontal direction.

LT-DFZ90-1

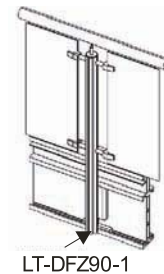

LT-DFZ90-1 is a handrail upright extrusion with the height of 1078mm.

LT-DFZ/H

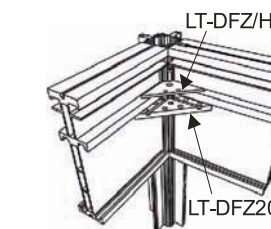
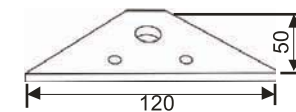

LT-DFZ/H is used to fix the horizontal damping.

LT-DFZ115

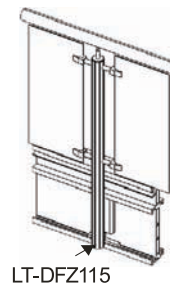

LT-DFZ115 is a handrail upright extrusion and its height is 1328mm.

LT-DFZ25

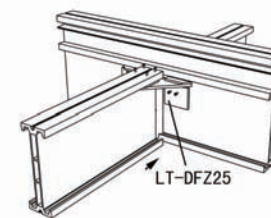
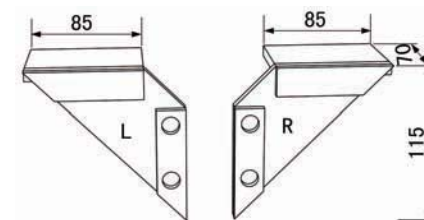

LT-DFZ25 is used to strengthen the connection of the coupling beam and the supporting beam.

LT-DFZ/V9

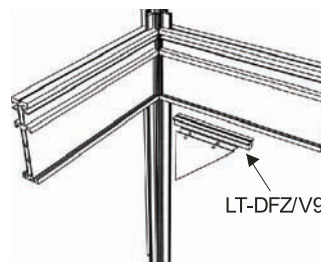
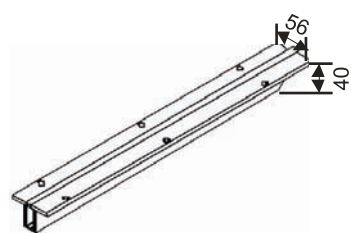

LT-DFZ/V9 is a stable profile. It connects the LT-DFZ/V9-1 with the supporting beam of the second floor.

LT-DFZ36

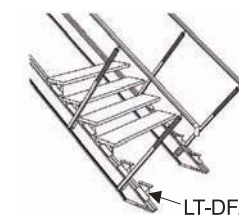
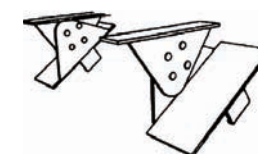

LT-DFZ36 is step fixing set. It is installed on the support beam of staircase to fix the staircase board.

LINGTONG Double Deck

Double Deck

Double Deck

LT-DFZ/K1

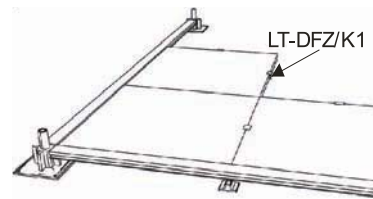
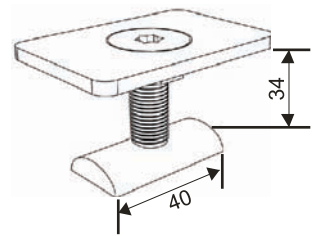

LT-DFZ/K1 is a flush bolt. It is used for reinforcement and intensity in case of the dislocation between two adjacent floors.

LT-DFZ71

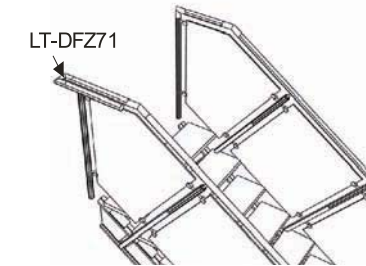
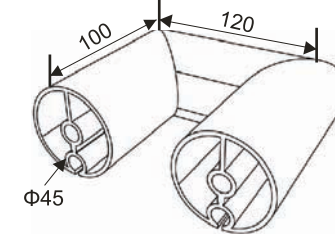

LT-DFZ71 is a handrail connector at 180°.

LT-DFZ/BE

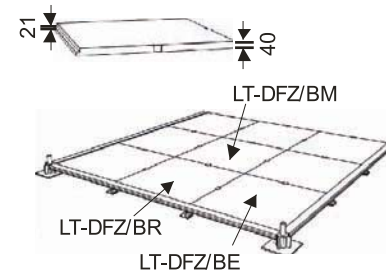
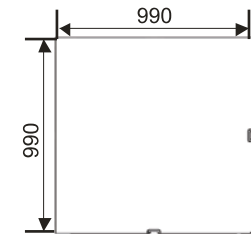

LT-DFZ/BE is a corner floor panel. This kind of floor is used in four corners of the second floor. Both sides are inserted into the floor profile after milling and other points are supported by the adjustable foot.

LT-DFZ72

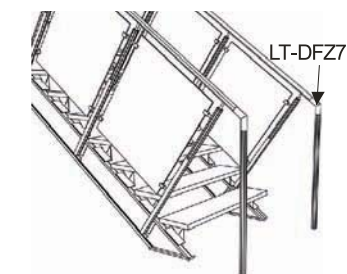
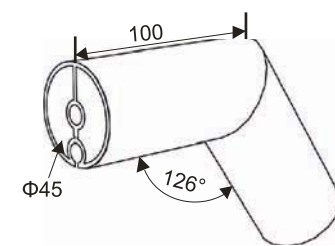

LT-DFZ72 is a handrail connector at 126°.

LT-DFZ/BR

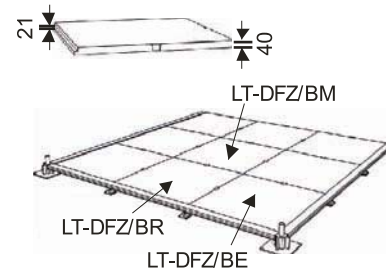
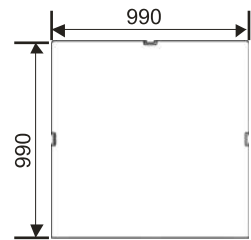

LT-DFZ/BR is the edge floor panel which is used around the second floor. One of its sides is inserted into the floor profiles after milling and other points are supported by the adjustable foot.

LT-DFZ73

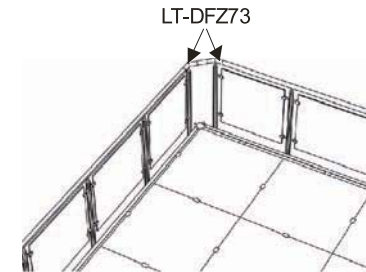
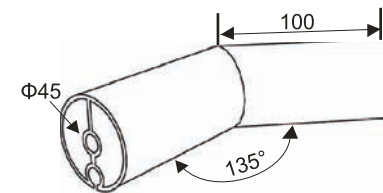

LT-DFZ73 is a handrail connector at 135°.

LT-DFZ/BM

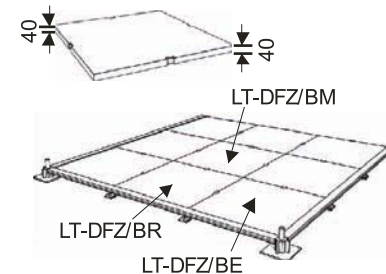
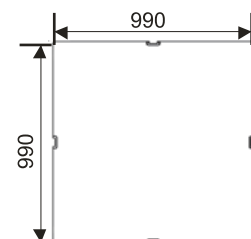

LT-DFZ/BM is the middle floor panel with all points supported by adjustable foot.

LT-DFZ74

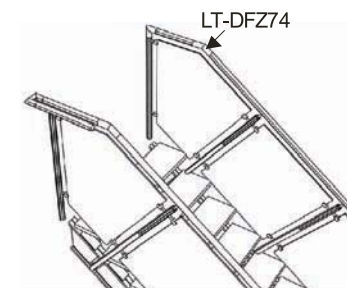
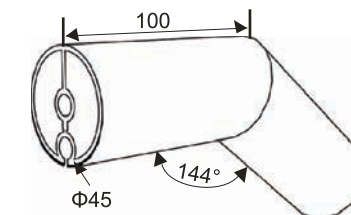

LT-DFZ74 is a handrail connector at 144°.

LT-DFZ70

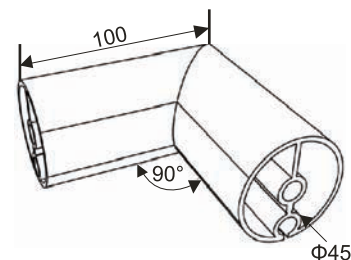

LT-DFZ70 is a handrail connector at 90°.

LT-DFZ91

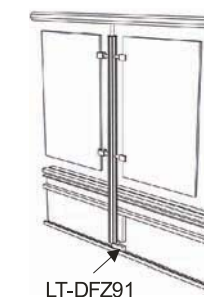
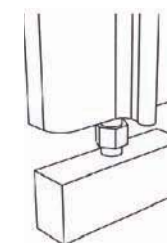

LT-DFZ91 is a connecting bracket. It can reinforce LT-DFZ91A-3J by adjusting the bolt so as to fix the handrail upright extrusion.

LINGTONG Double Deck

Double Deck

Double Deck

LT-DFZ/HF1

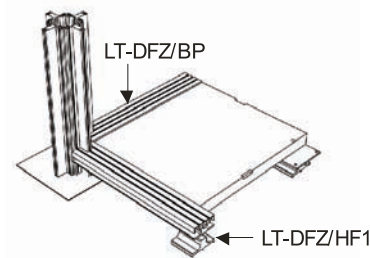
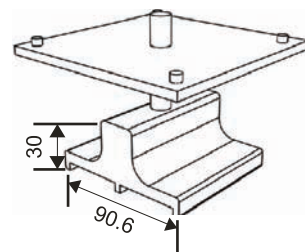

LT-DFZ/HF1 is an adjustable foot. It is the main support of the floor. By adjusting the height with a screw, it can solve the problem of irregular ground.

LT-DFZ35

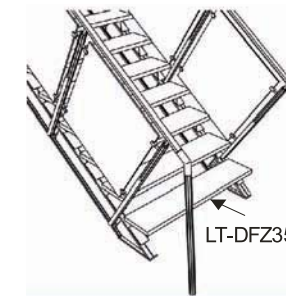
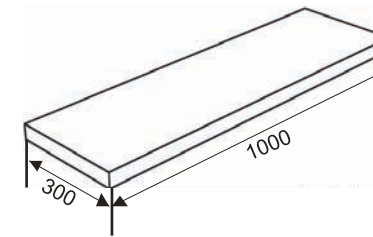

LT-DFZ35 is a foot plate for staircase. It is a kind of middle density board with the thickness of 40 mm.

LT-DFS10

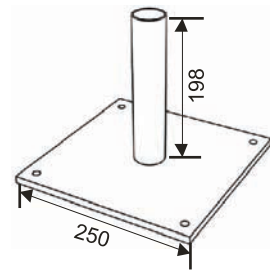

LT-DFS10 is the base plate of the cross extrusion.

LT-DFZ90

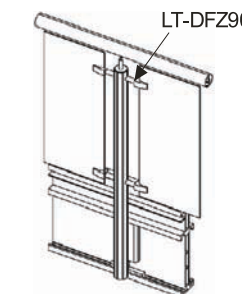
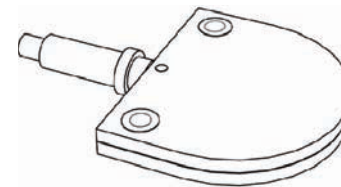

LT-DFZ90 is a connector for glass clamp which can fix 8mm glass.

LT-DFZ56/N

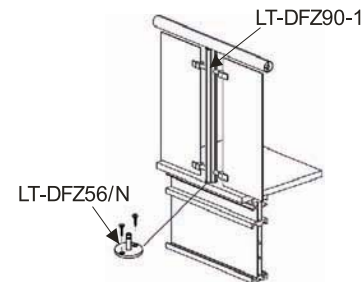
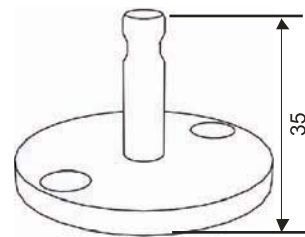

LT-DFZ56/N is the connecting base of the handrail upright profile by which the handrail upright extrusion can be directly attached to the floor.

LT-DFZ58

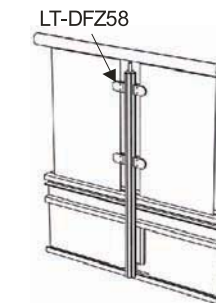
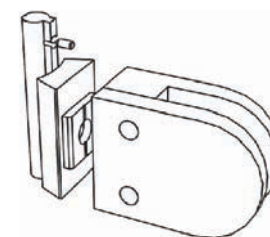

LT-DFZ58 is a glass clamp. It can fix 8mm glass.

Installation of Double Deck

01

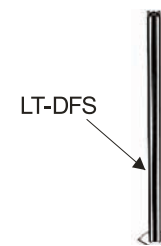

Installing the cross extrusion with the base plate.

02



To locate other extrusions on second floor.

03



Adjustable foot to be installed on the floor extrusions and then inserted into the cross extrusion.

LT-DFZ61

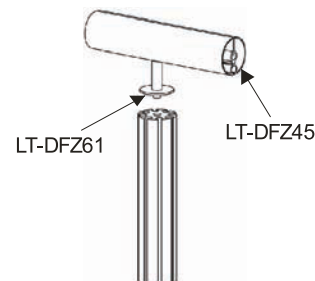
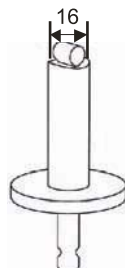

LT-DFZ61 is an intensive connector which connects handrail upright extrusion with LT-DFZ45.

LT-DFZ57

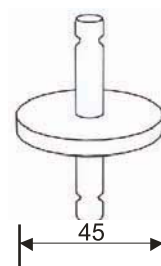

LT-DFZ57 is a connector used to connect two banister extrusions or a banister extrusion and a connector.

LINGTONG Double Deck

Installation of Double Deck

Photos of Double Deck

04

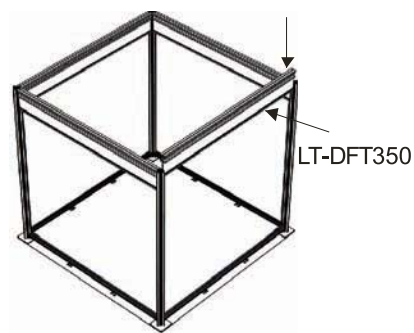

To install the supporting beams one by one.

05

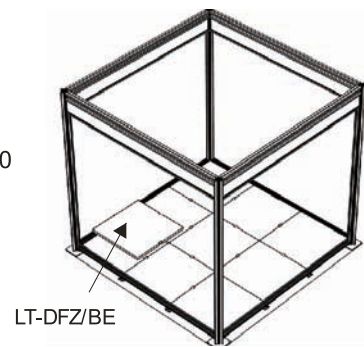

Then the first floor to be installed.

06



To install the coupling beams of the second floor and reinforce them.

07

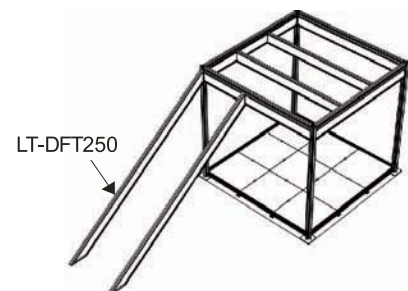

To install the handrail of the second floor.

08

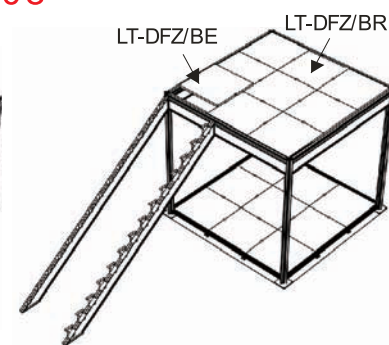

Installing the flooring on the second floor.

09

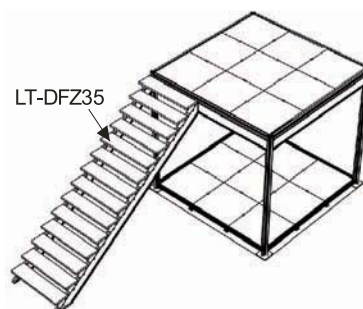

To set the foot plate for staircase of the second floor.

10



To install the handrail and the parapet railings.

11

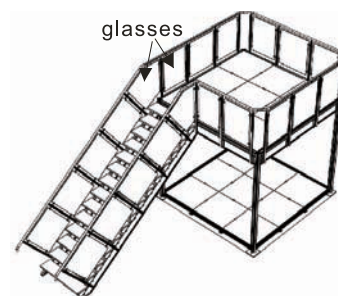

Finally to install the glasses then the main framework of the double deck is finished. It can bear 350kg/m².

