

- Bring Eco-friendly Display System into every show space



LINGTONG EXHIBITION SYSTEM CO., LTD.

LINGTONG

Modular System

Clad Wall

Complete-Set Wall

Frameless Fabric Cube

LT SYSTEMS

Full Service

Reduce Reuse Recycle

Low-carbon and Environment-friendly

A full line of system

Quick Assembly

One-stop service



Address: NO.333, Changhong East Road, Yaoguan, Wujin, Changzhou, Jiangsu, China

Post code: 213102

Tel: 0086-519-88702888 88702558 88702568

Fax: 0086-519-88701653

Email: lintong@ling-tong.cn

<http://www.ling-tong.com>

Toll free: **800-828-6786**

201611-01



Complete set wall system		A
1.The Major Trusses of Complete-set wall	02	
2.Modular System of Complete-set wall	03	
3.Application Cases	04-08	
Series of Framless Fabric Cube		B
1.Sizes and accessories of Fabric Cube	09-10	
2.Standard fabric cube	11	
3.Application cases	12-13	
4.Case share	14-15	
5.Code & size list for fabric cube frame	16	

Note: Complete set wall system is a kind of modular wall system that use tension lock and a post that can hide between panels to make the connection.
 Complete set wall panel includes standard panel, complete set pegboard panel, complete set slat panel, complete set panel with AA post, and panel with doors. Panel with pegboard, slat and AA post are for product display.
 Also Lingtong complete set panel can show products by using peg panel with holes, steel net and shelf.

Major Profile

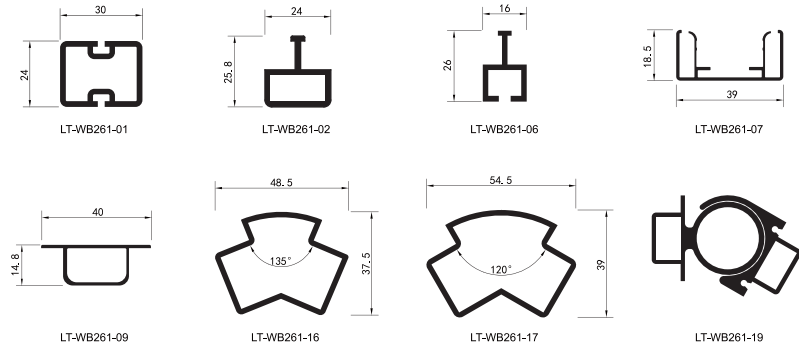

Major Panels



LT-WB261-04 Standard panel
 LT-WB261-04(WK) Complete set pegboard panel
 LT-WB261-04GCG Complete set slat panel
 LT-WB261-40 Complete set panel with AA post
 LT-WB261M Complete set panel with door

1. Standard size is 997×2400mm, special size can be customized.
2. Thickness of the panel is 40mm.
3. Usually the panel is white fire-proof.
4. 4 pcs of Tension Lock are built in the panel (Parallel & vertical 2 each).

Application Cases



Application Cases



Application Cases



Application Cases

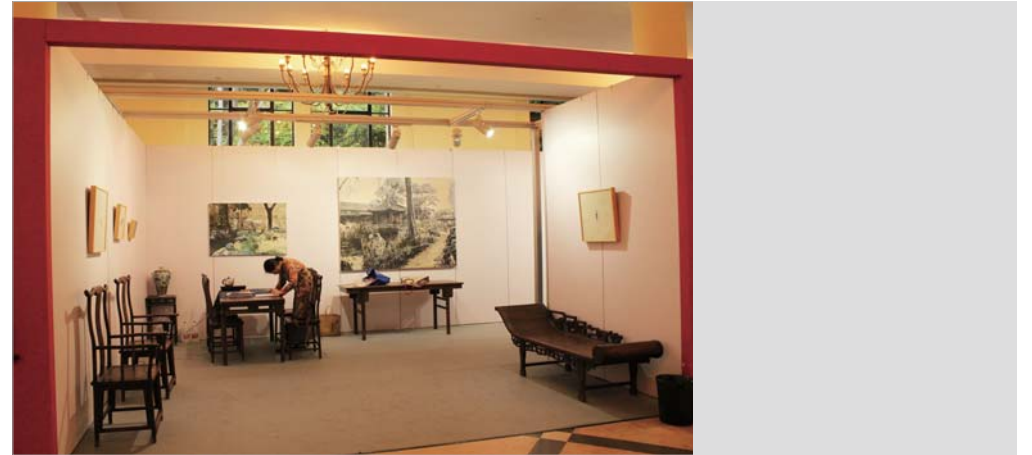

Application Cases



Sizes and accessories of Fabric Cube



LT-W3013

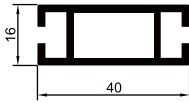

LT-Z4400

(The support beam should be used when the span of the frame is over 2m.)



Knuckle Joint LT-S1586



LT-WB765-05



LT-WB765-03



Connecting Diagram

Frame is exposed on the corner which is common in the market. Affect the appearance. LT-W3013 changed this defect, frame is not exposed.

Application: Ceiling shape and Image display in commercial space.

It can be suspended by the fitting LT-WB765-05 and the hook EG417-1.





If the frame is too large, we need LT-WB765-03 and beam to support.

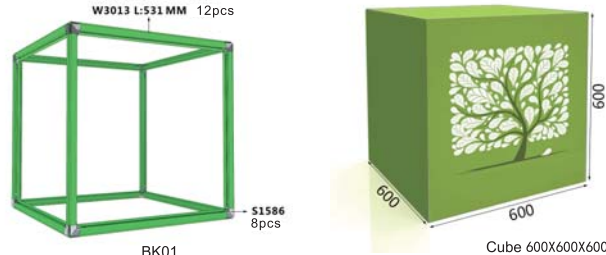
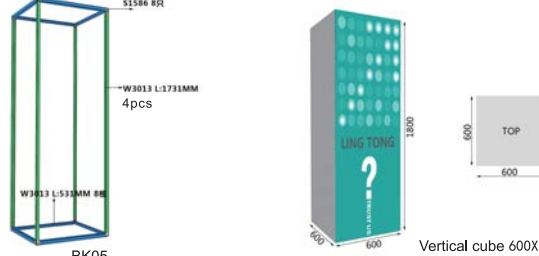
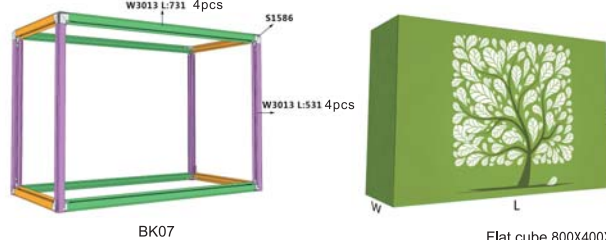

Beam Extrusion/40mm

Standard fabric cube (Specific models see schedule 2)

<p>Square cube</p>	 <p>BK01 Cube 600X600X600</p>
<p>Vertical cube</p>	 <p>BK05 Vertical cube 600X600X1800</p>
<p>Flat cube</p>	 <p>BK07 Flat cube 800X400X600</p>
<p>Cube sign</p>	 <p>BK10 Cube sign: 1000 (L)*400 (W)*2200 (H)</p>

Application cases

① Modular Combination of regular hexahedron

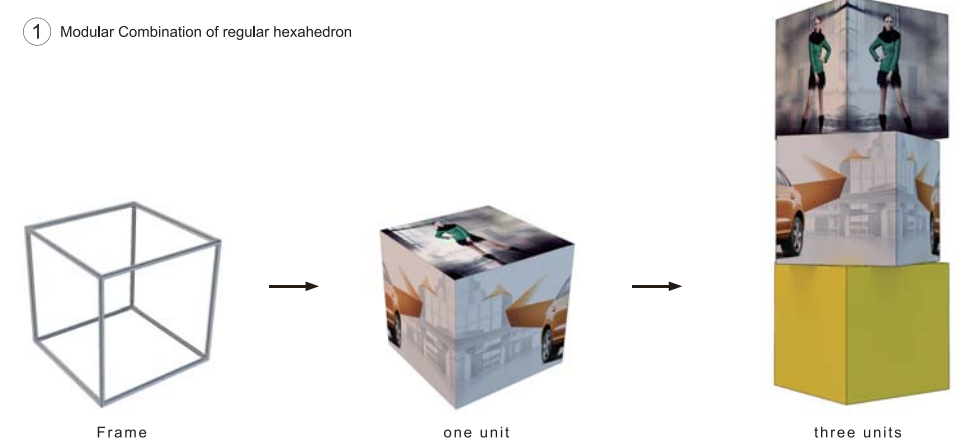

Frame → one unit → three units



② Combination of square cube and vertical cube

Application cases

Square cube	
Flat cube	

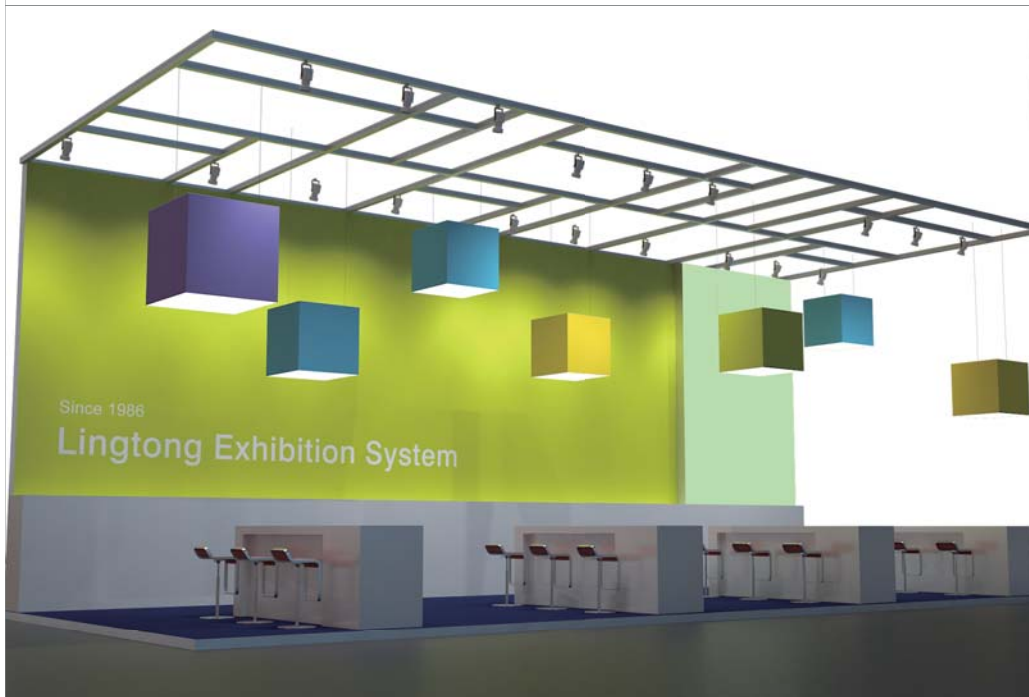

Case share

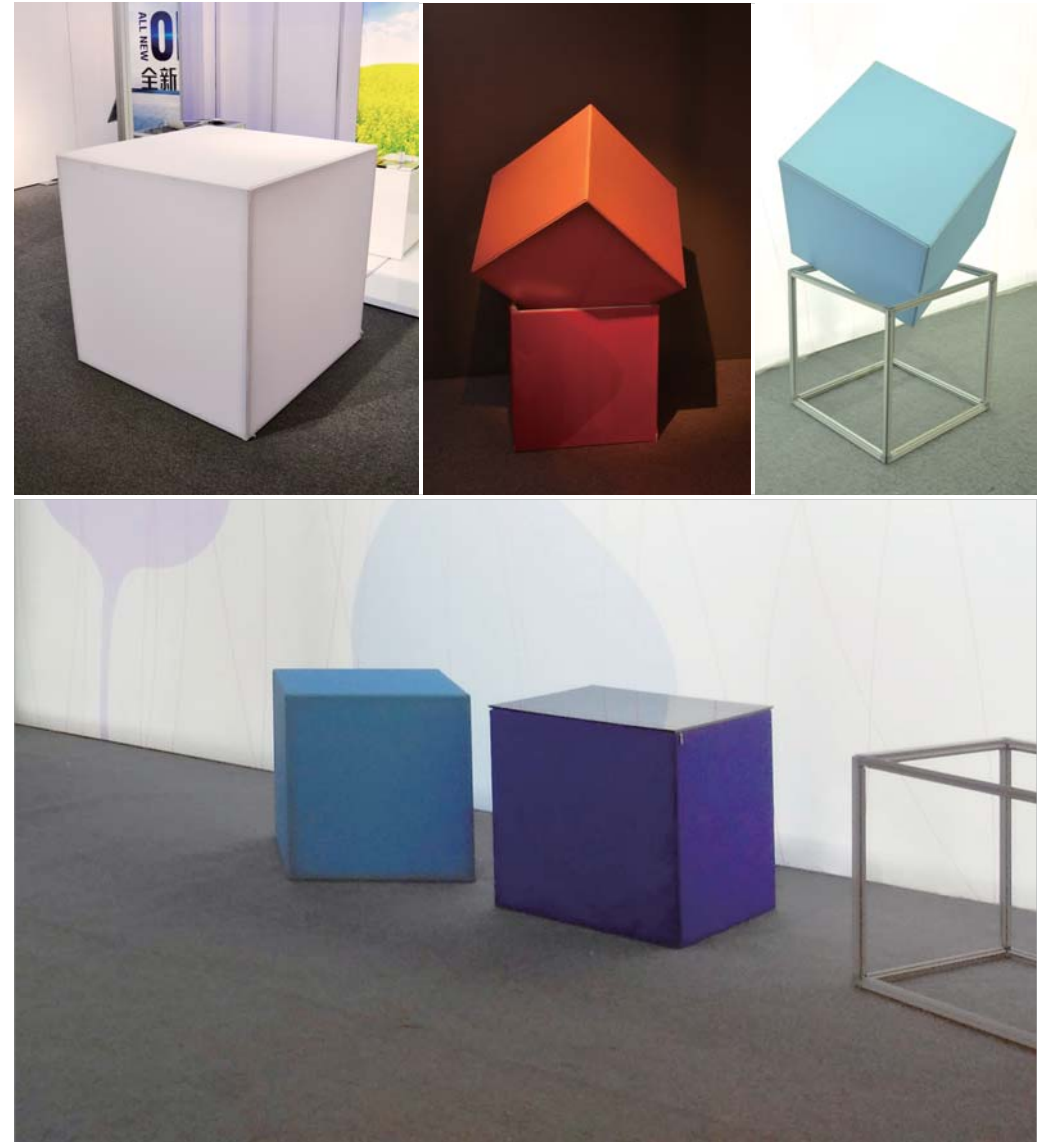

Case share



Code & size list for fabric cube frame

Category	No.	Code	Name	Size
Square cube	1	BK01	600 Square cube	600x600 x600
	2	BK02	800 Square cube	800x800 x800
	3	BK03	1000 Square cube	1000x1000 x1000
	4	BK04	1200 Square cube	1200x1200 x1200
Vertical cube	5	BK05	1800 Vertical cube	600x600 x1800
	6	BK06	2200 Vertical cube	800x800 x2200
Flat cube	7	BK07	Flat cube	800x400 x600
	8	BK08	Flat cube	1200x400 x600
	9	BK09	Flat cube	1200x400 x800
Cube sign	10	BK10	Cube sign	800x400 x2200
	11	BK11	Cube sign	1000x400 x2200

BK: Fabric Frame

Remark:

Above is the standard size, other sizes need to be customized.