

LINGTONG
EXHIBITION

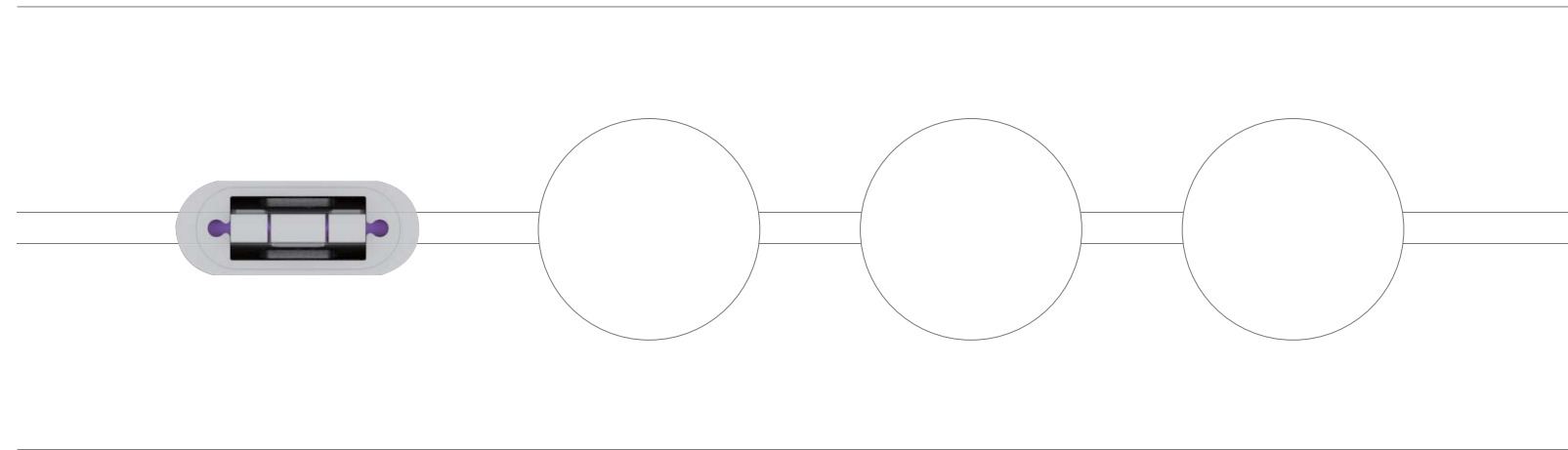

Address: NO. 333, East Changhong Road, Yaoguan, Wujin, Changzhou, Jiangsu, 213102, China
Tel: 0086-519-88702328, 88709127, 88700098
Fax: 0086-519-88701653
Email: LINTONG@LING-TONG.CN
WWW.LING-TONG.COM





LT-FAST
LINGTONG FAST SYSTEM

A TOOL-FREE DISPLAY SOLUTION

LINGTONG EXHIBITION SYSTEM CO., LTD.

Content

L I N G T O N G F A S T S Y S T E M

	Introduction	P2-P4
	LTFS40	P5-P8
	LTFS60	P9-P18
	LTFS80	P19-P26

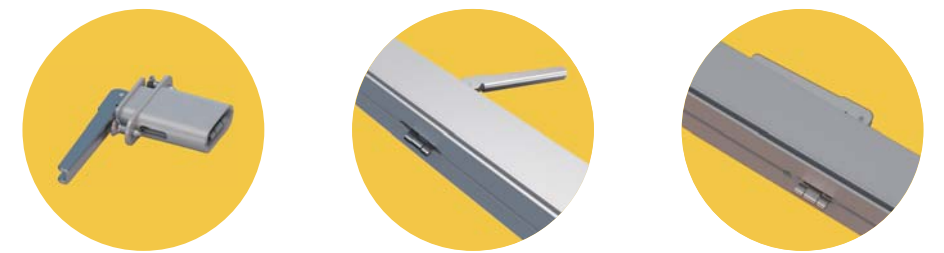

Introduction

Lingtong Fast System contains three kinds of frames: 40mm, 60mm, 80mm. Frames are connected by a toolless lock, and the skin can be LED, SEG fabric, or 3mm panel. It is widely used in standard booths and customized booths. Due to the convenience of the connection between the frames, it can be easily and quickly constructed, and the skin can be changed easily.



www.ling-tong.com

Realisations



LTFS40 Sizes

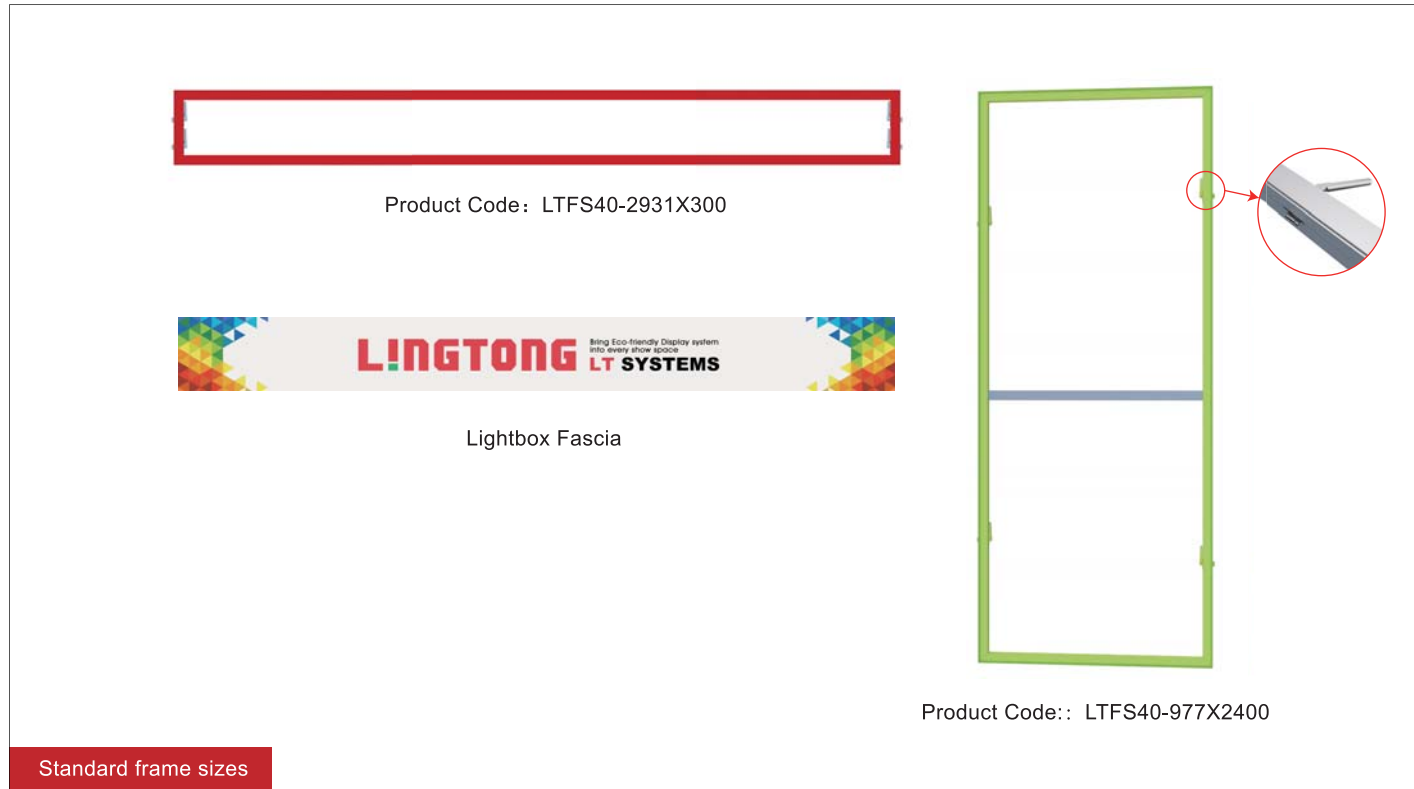

Fabric frame - Shell scheme booth size (mm)

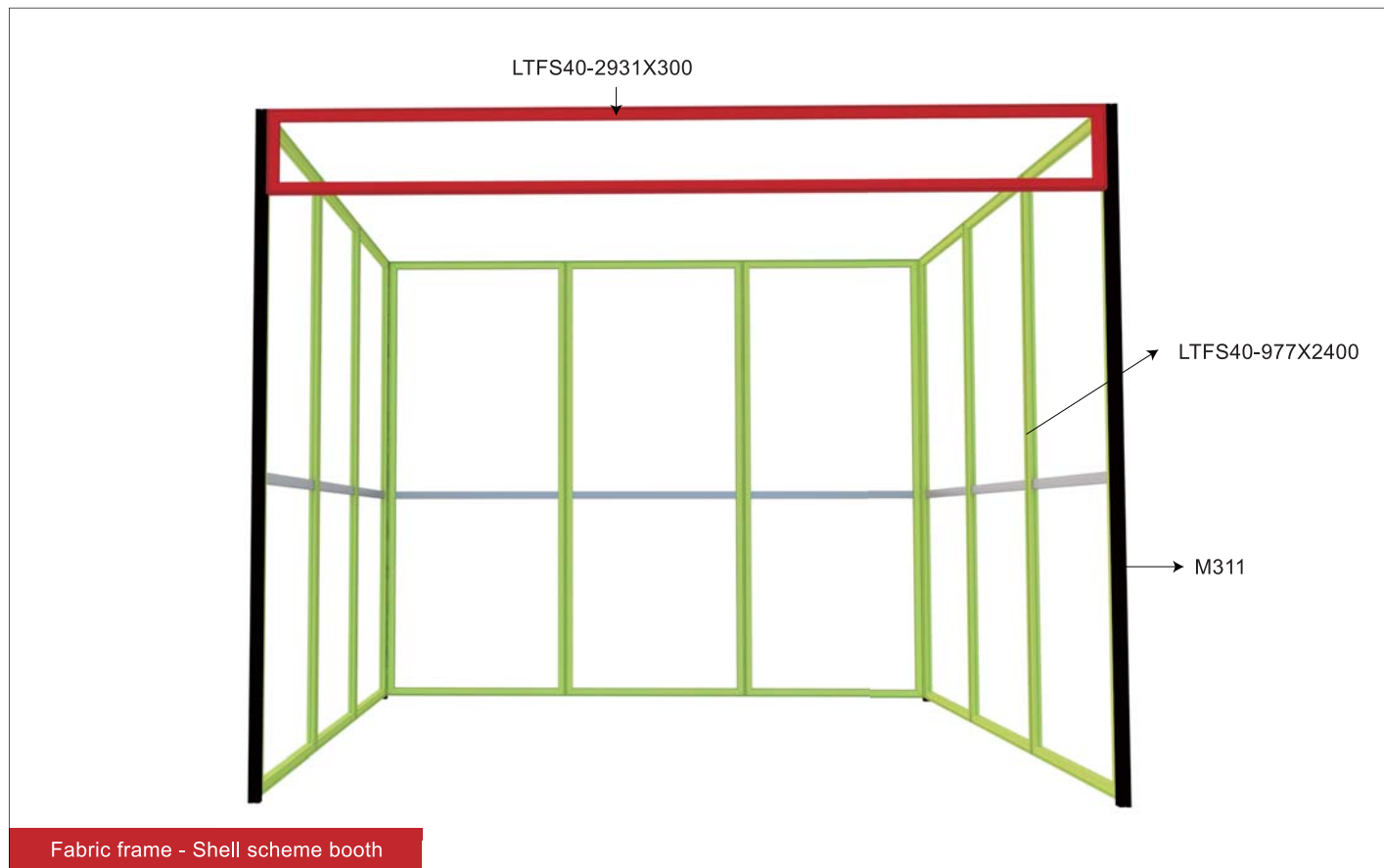
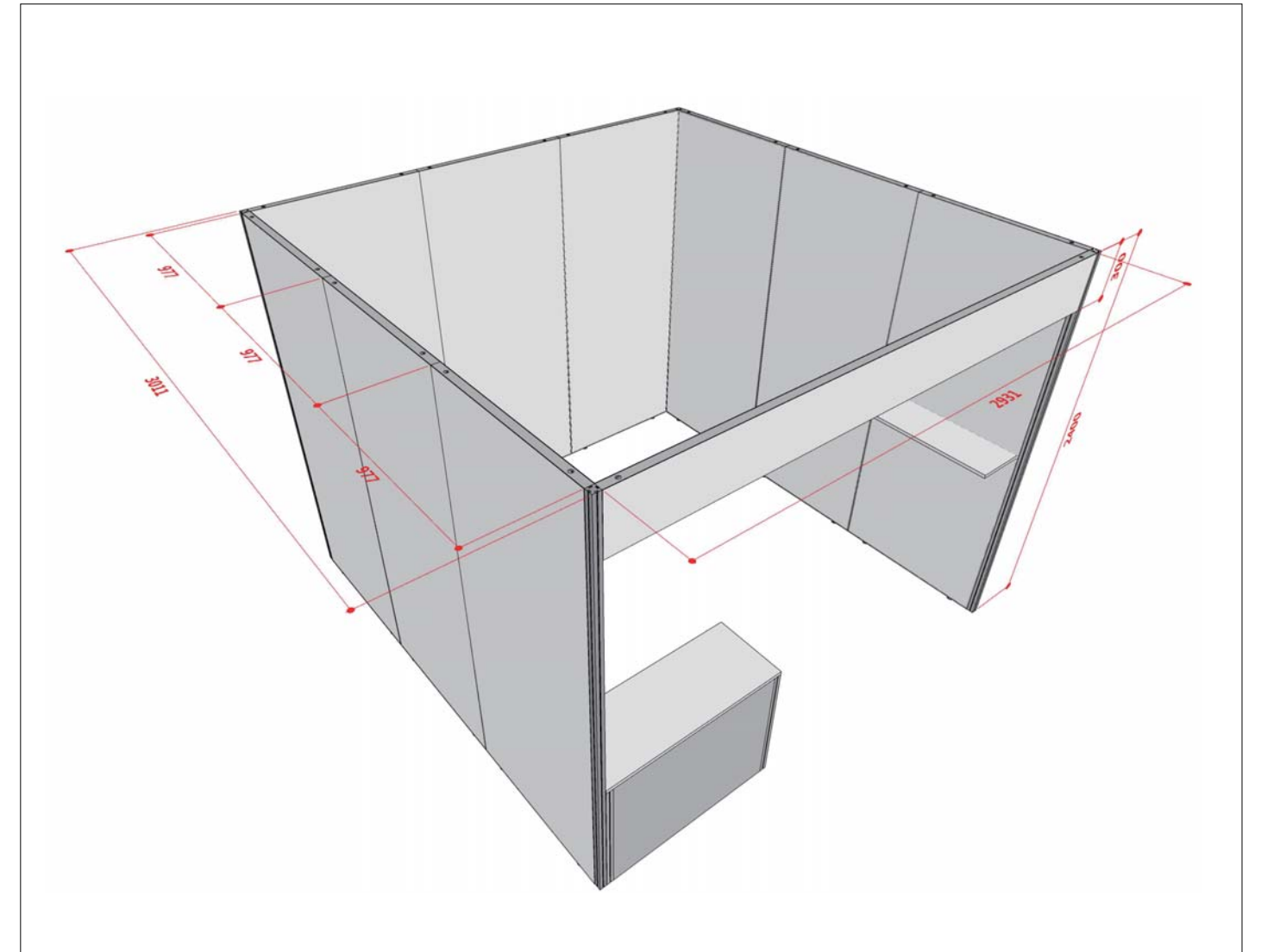

Magnetic bracket & shelf (loading capacity 5kg)

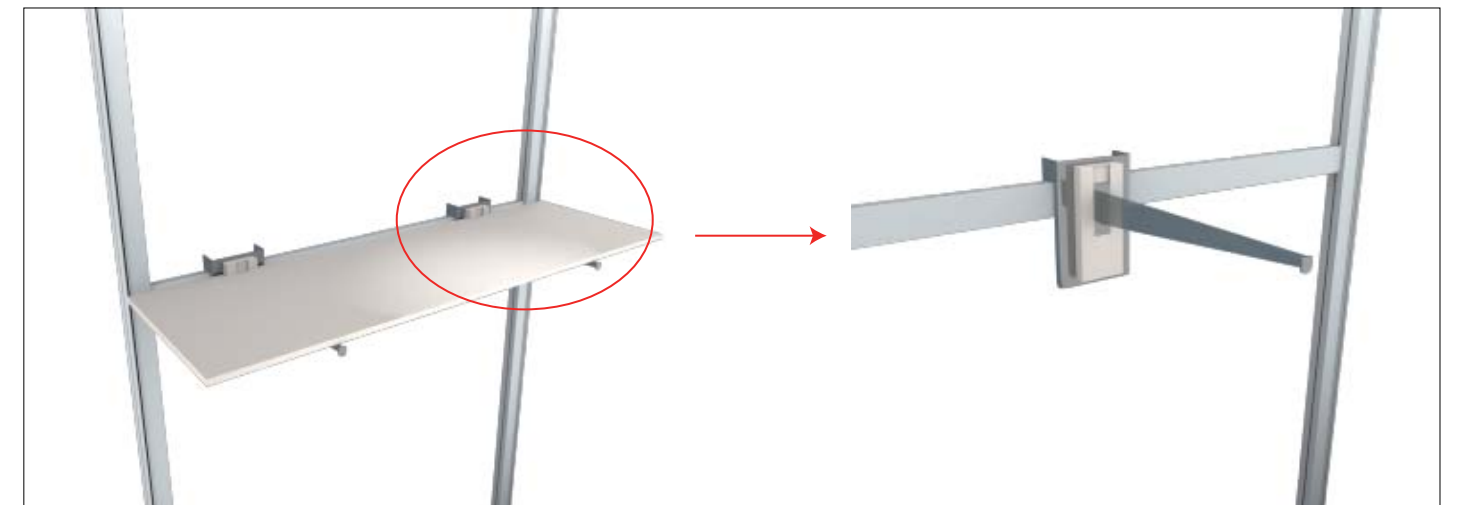

LTFS40 - Package (optional)

Steel frame crate	item	chairs	fabric	aluminum frames	lights	shelves	accessories	40mm square extrusion
	qty	6	40	20	6	6	12	12

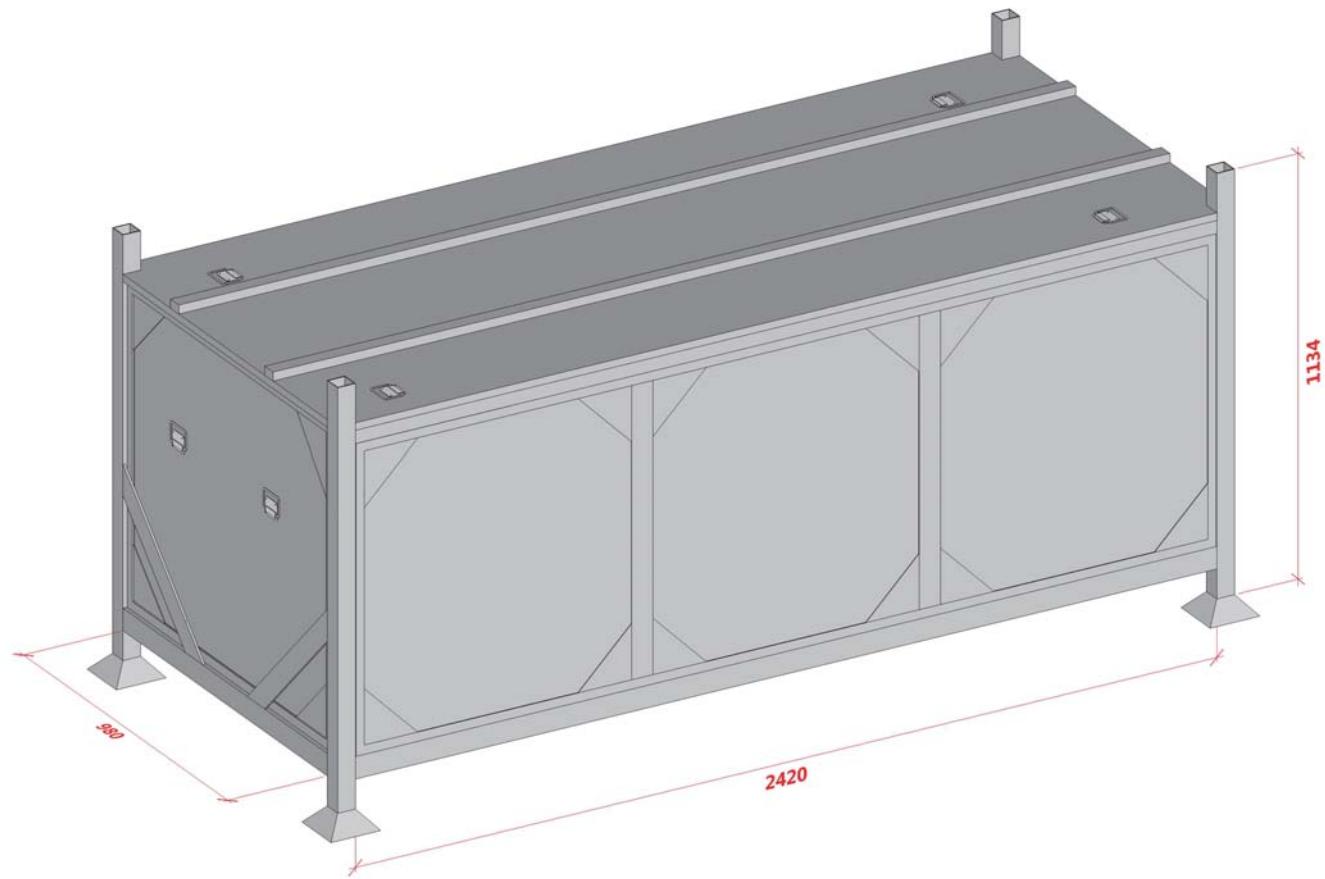

LTFS40 - Design cases



Three ways to display your graphic on LTFS60 and LTFS80

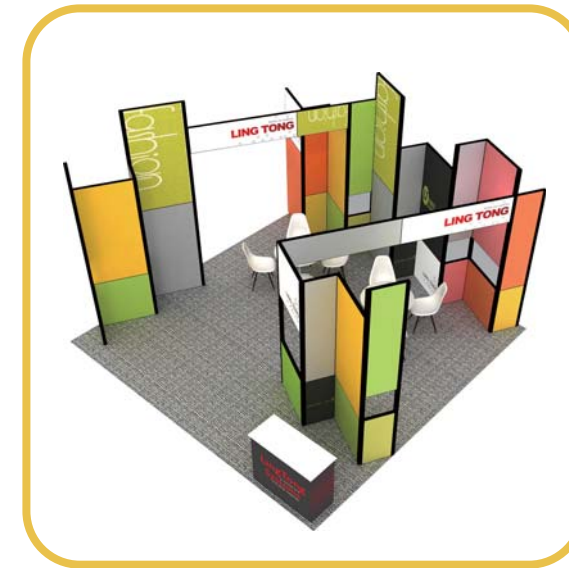

3mm Panel

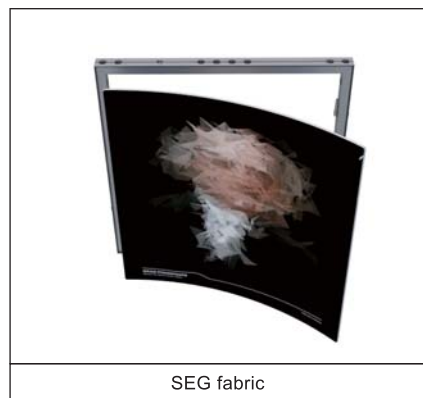

SEG fabric

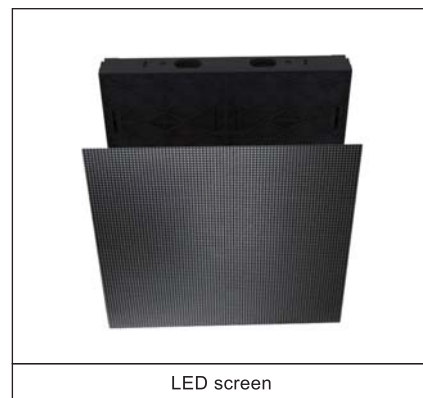

LED screen



LTFS60 Sizes

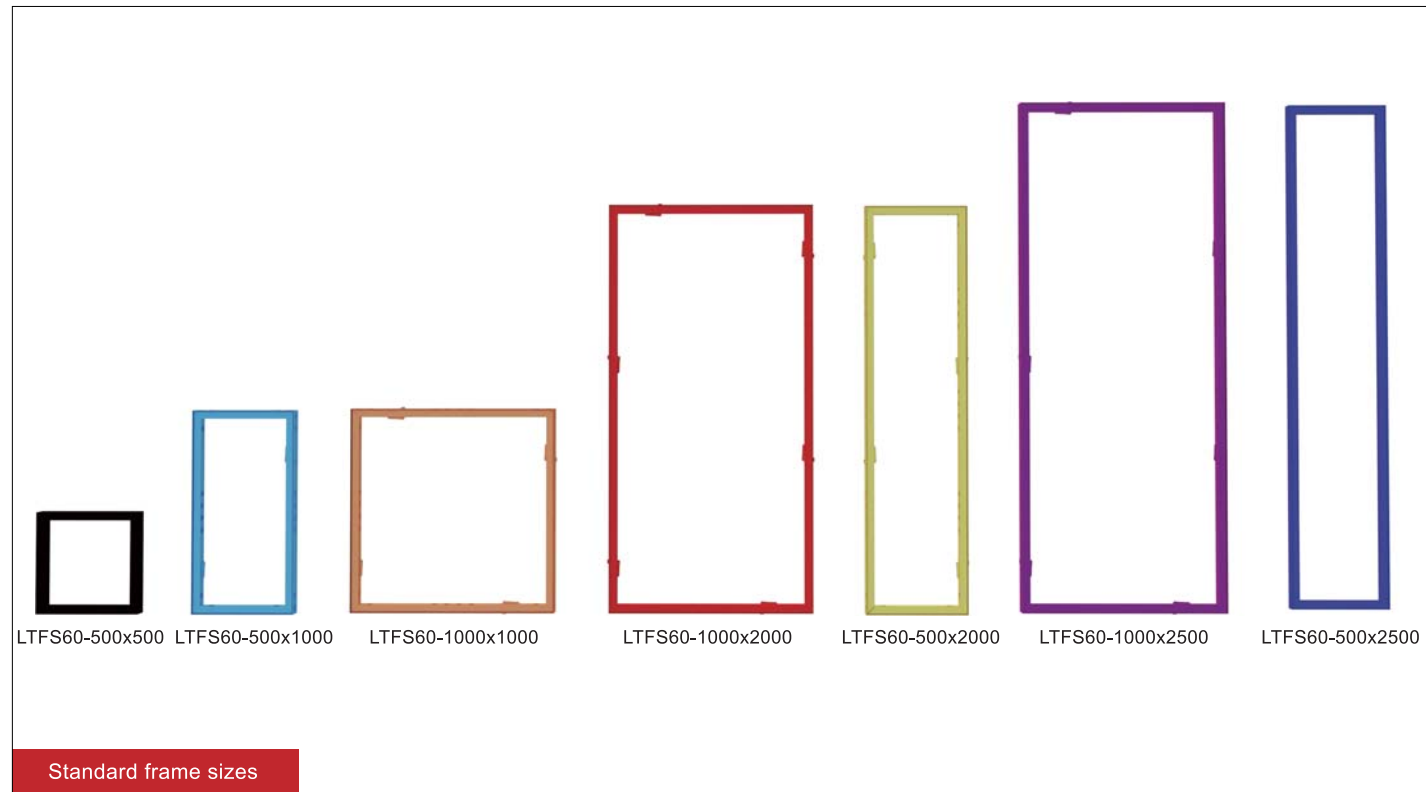

LTFS60 Sizes

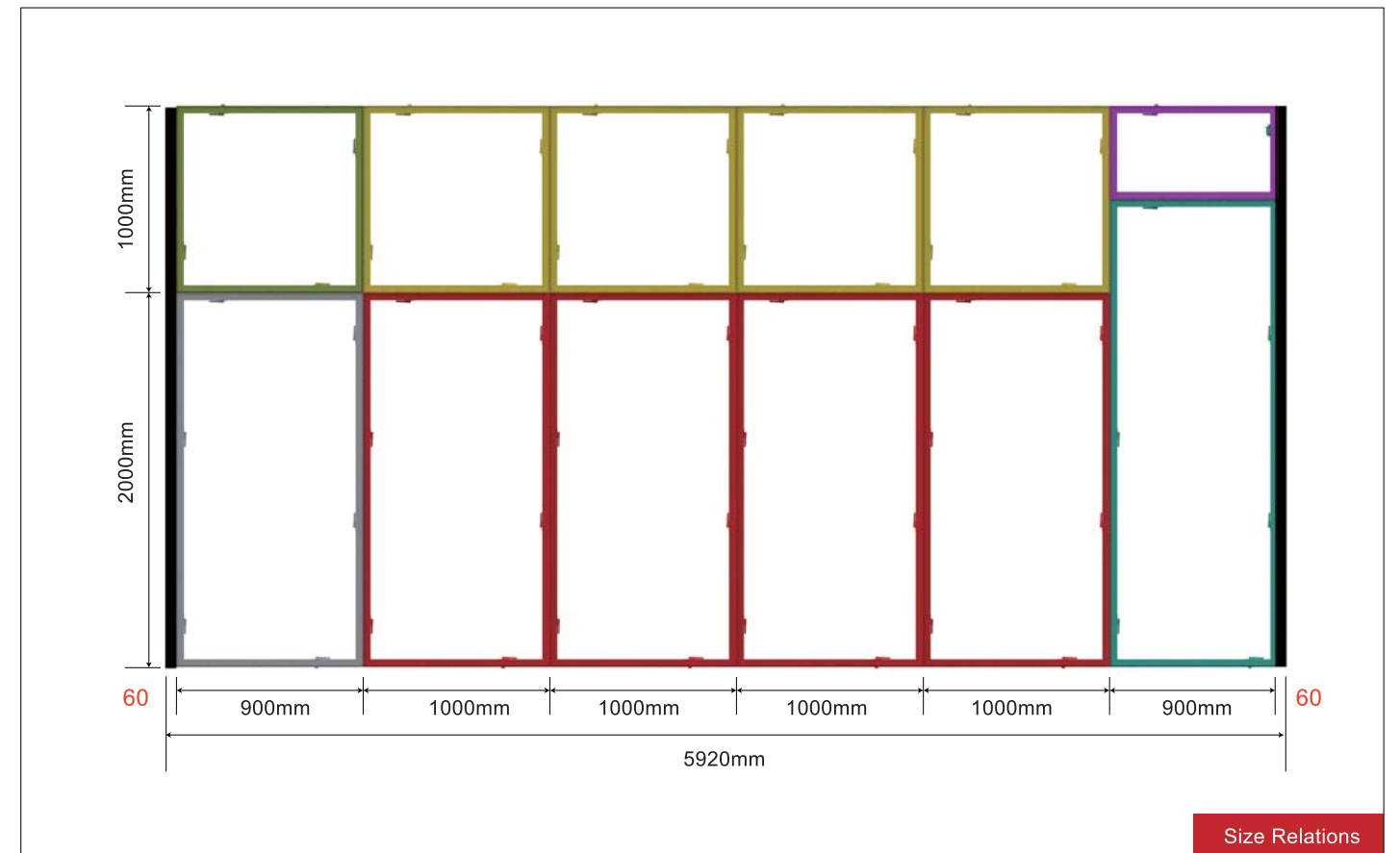
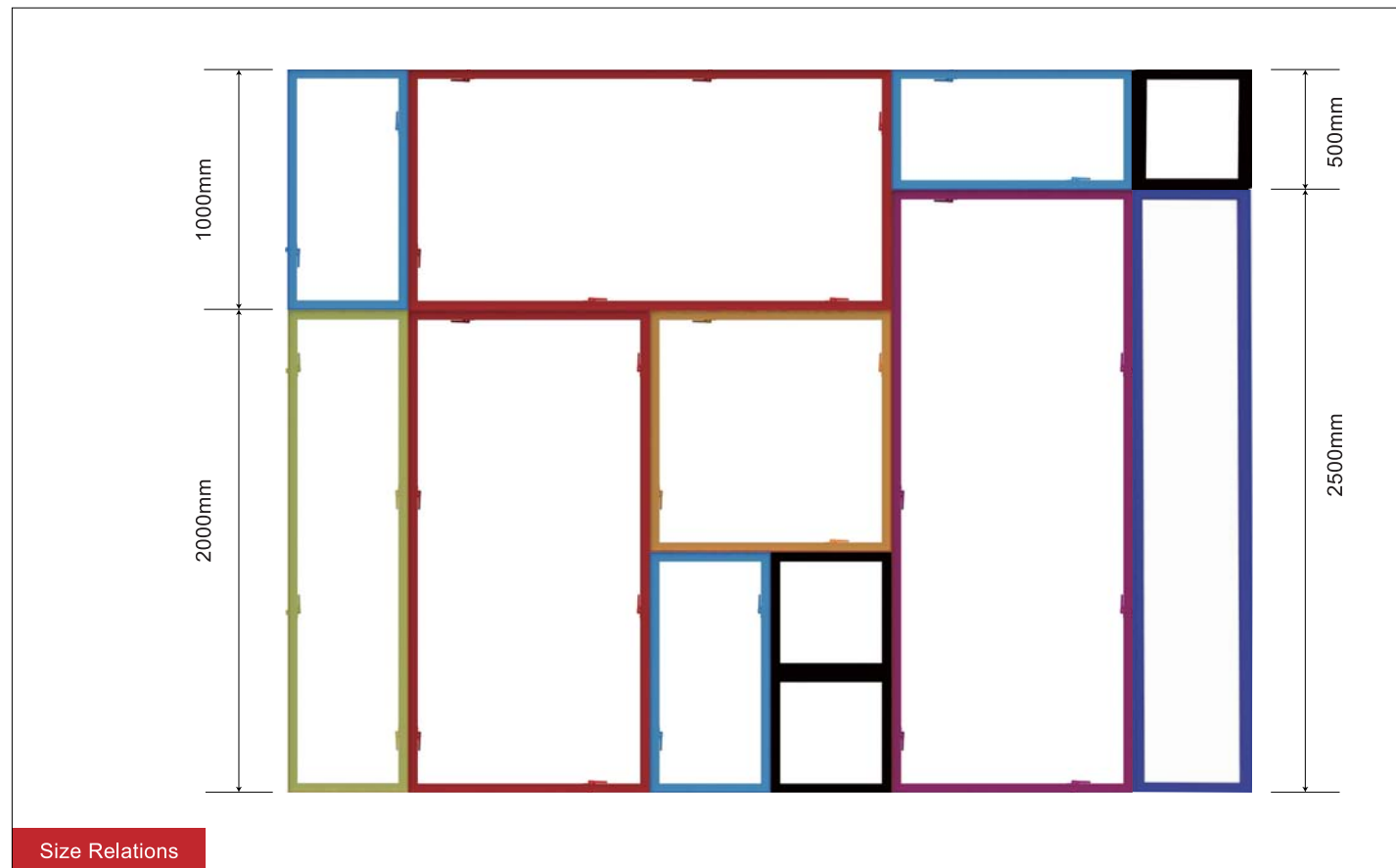
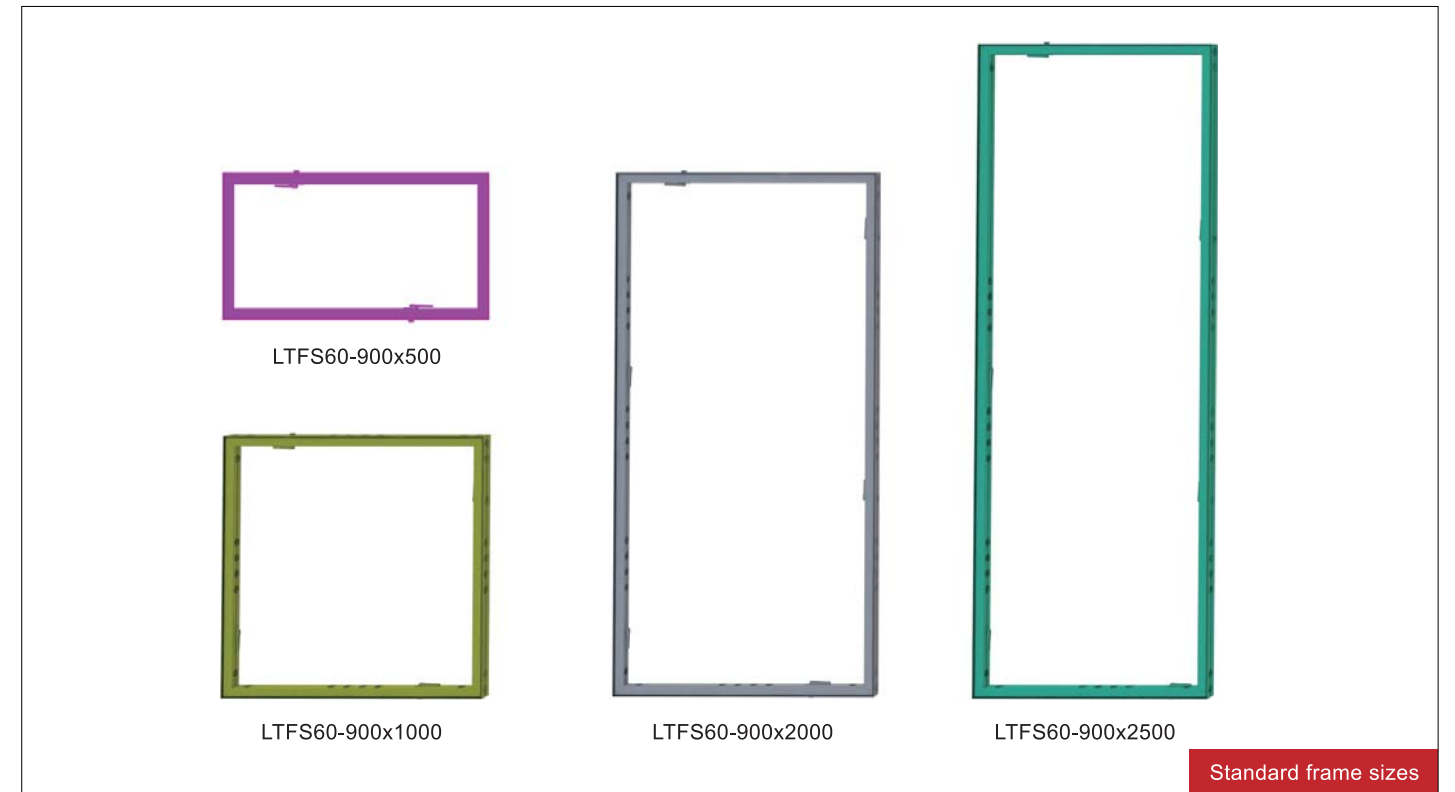

LTFS60 with LED screen

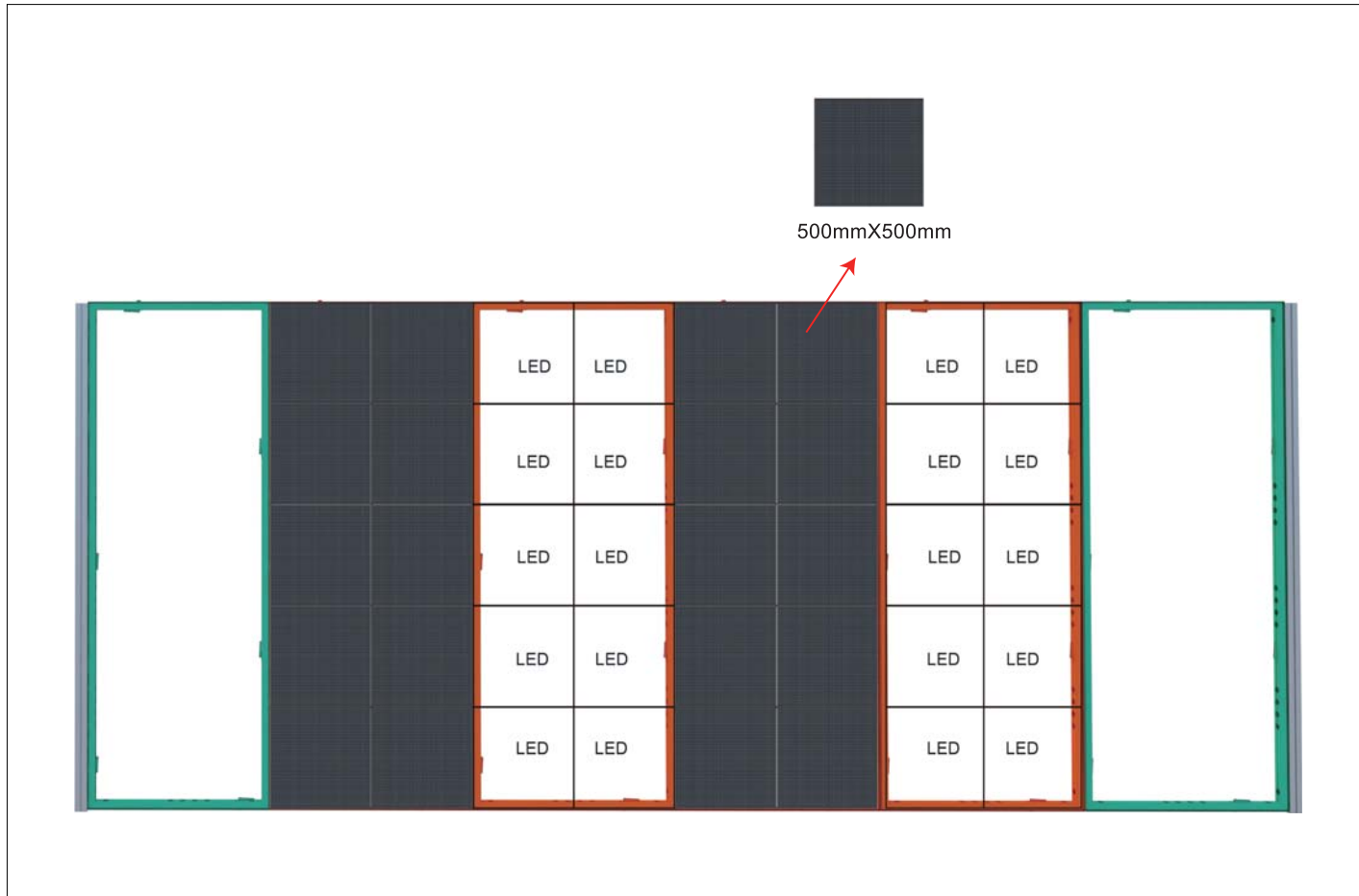

LTFS60 Curve

Product Code	Drawings	Product Code	Drawings
LTFS60-530x500S		LTFS60-1030x500S	
LTFS60-530x1000S		LTFS60-1030x1000S	
LTFS60-530x2000S		LTFS60-1030x2000S	





Kit Package

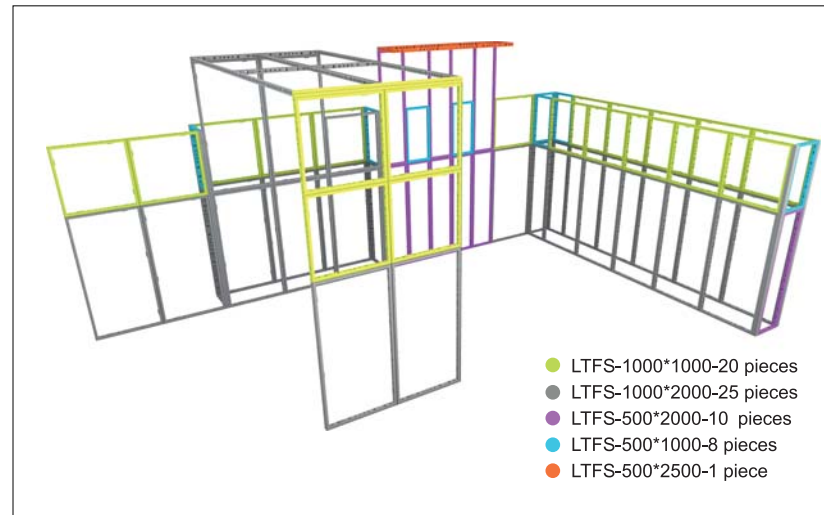

REALISATIONS

LINGTONG
EXHIBITION



REALISATIONS

LTFS80 Sizes

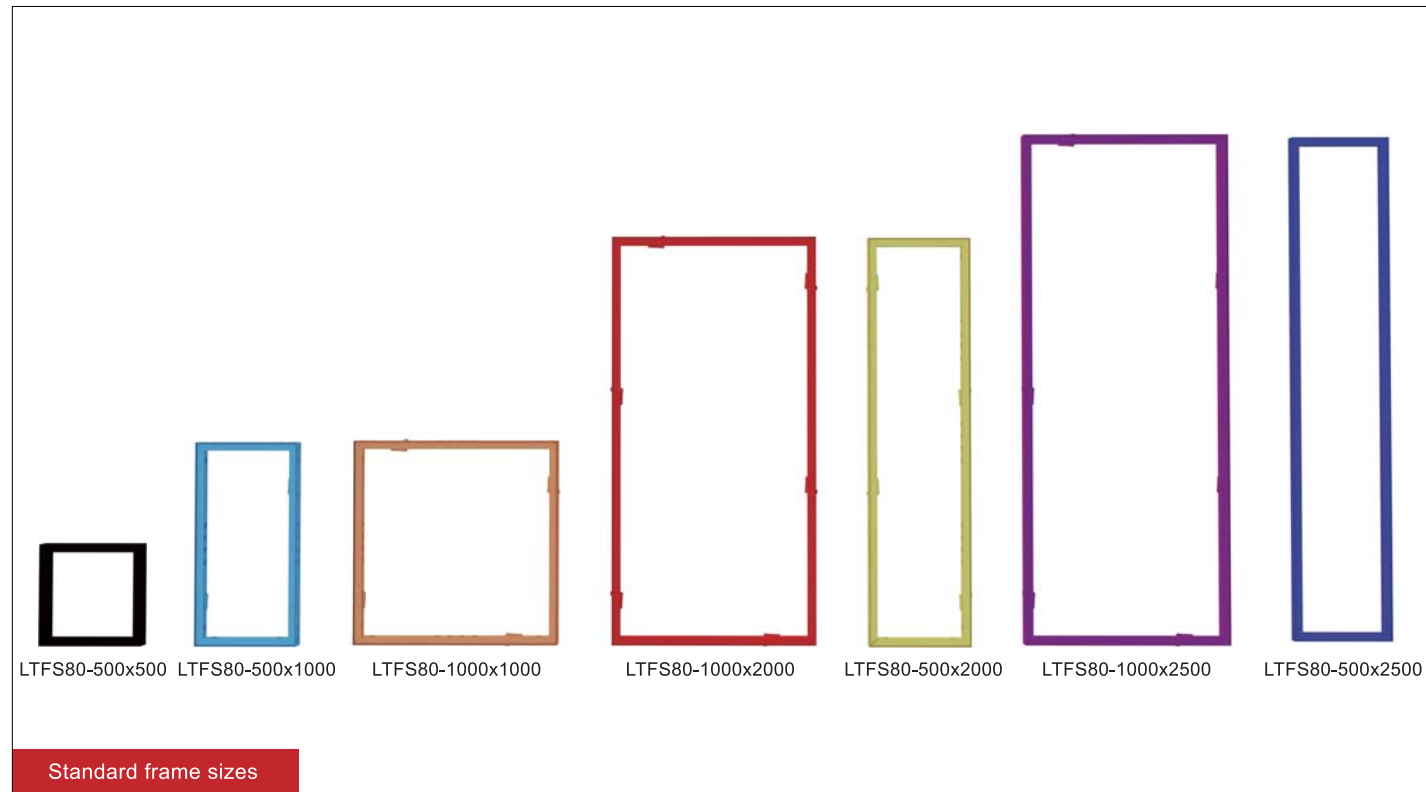

LTFS80 Sizes

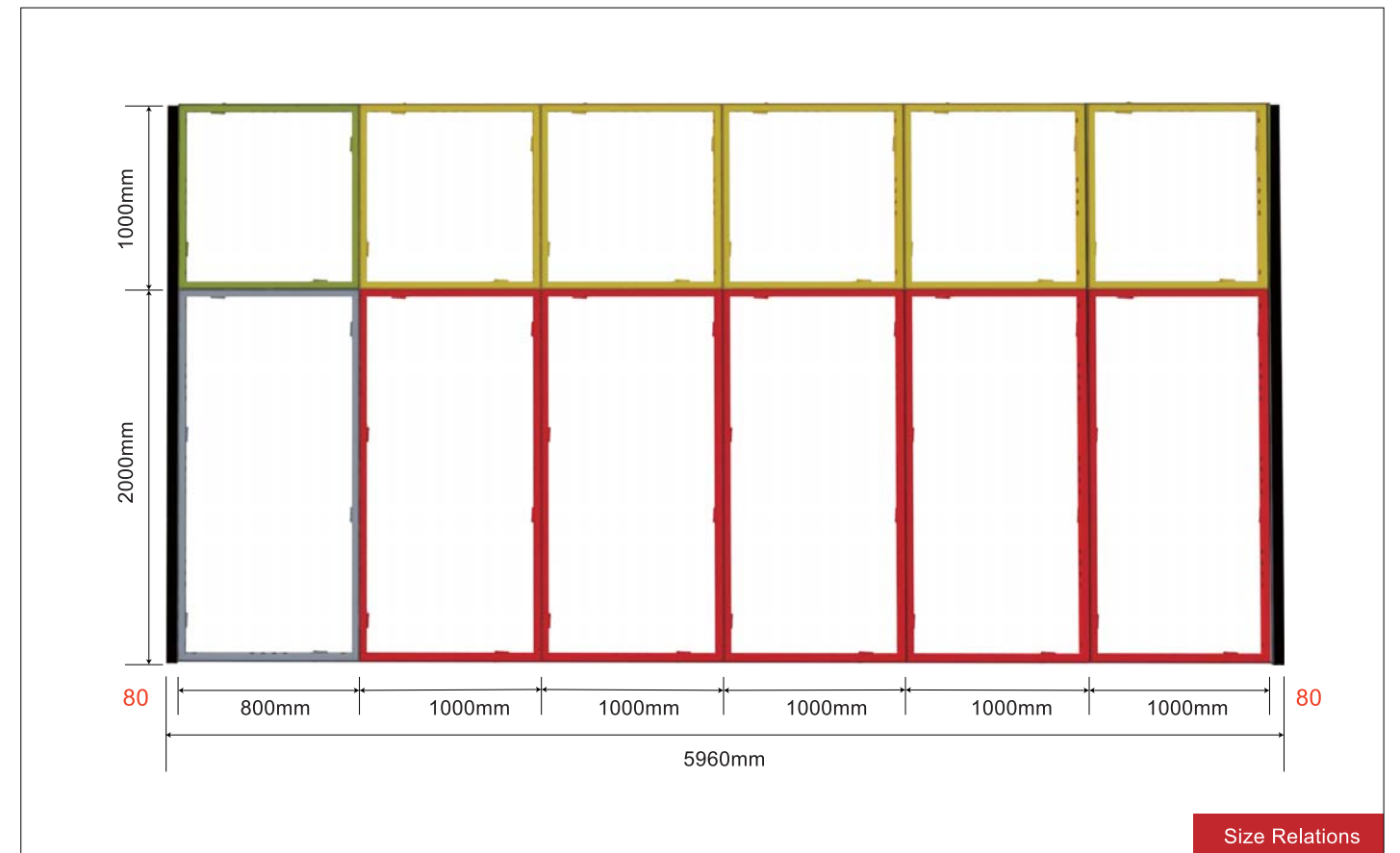
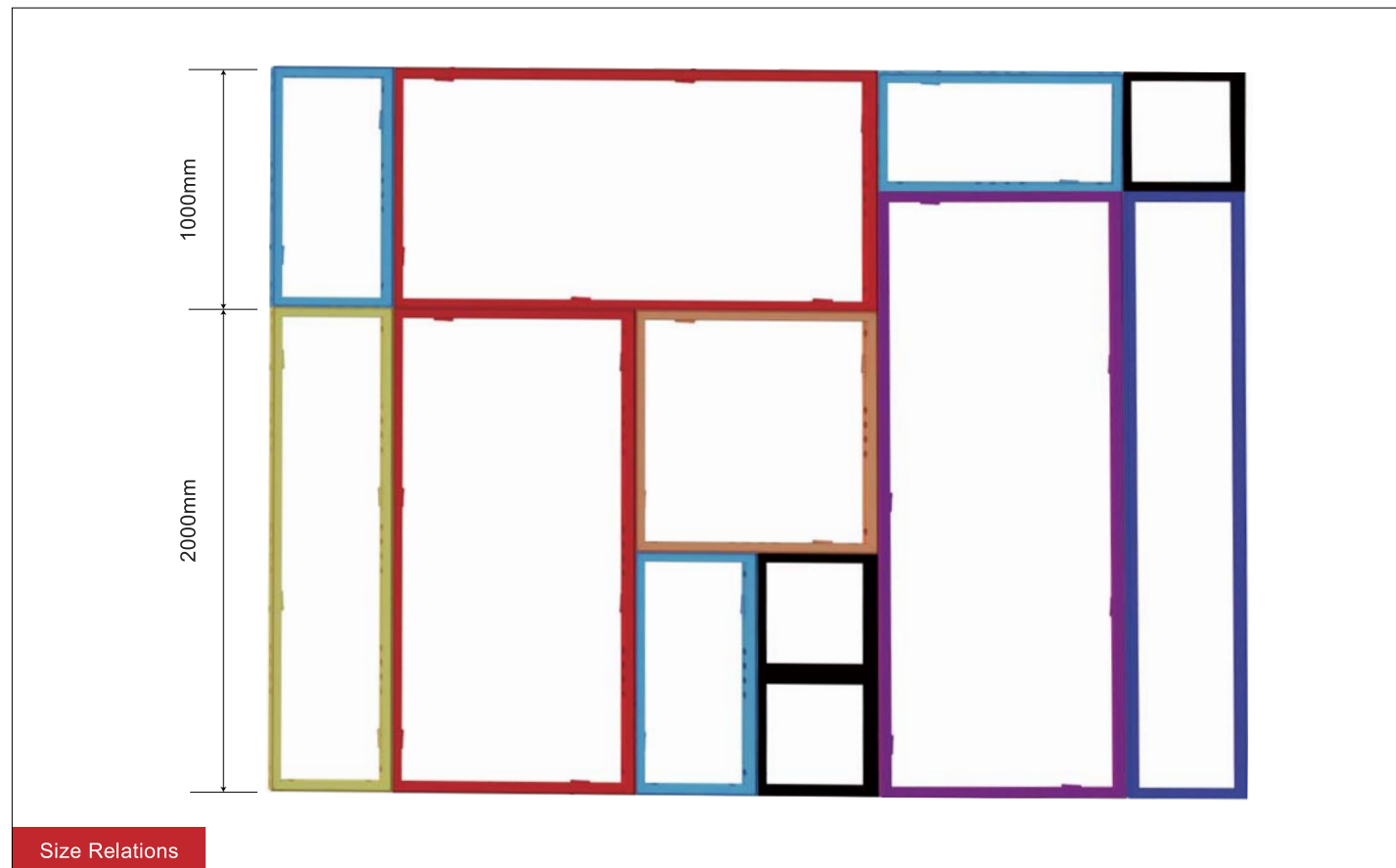
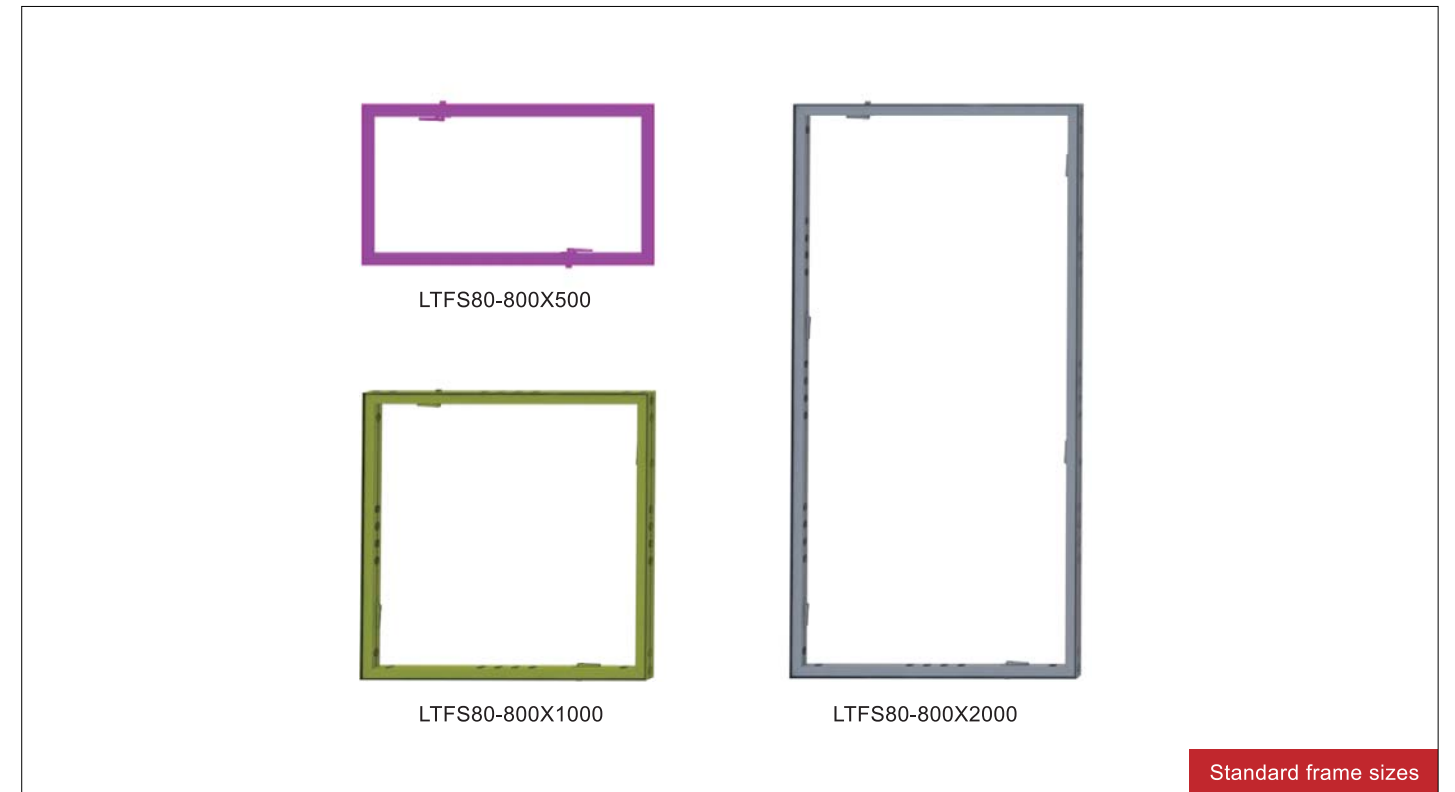

LTFS80 with LED screen



LTFS80 Curve

Product Code	Drawings	Product Code	Drawings
LTFS80-540x500S		LTFS80-1040x500S	
LTFS80-540x1000S		LTFS80-1040x1000S	
LTFS80-540x2000S		LTFS80-1040x2000S	



DESIGN IDEAS



Frames	Design Cases
<p>A 3D exploded view diagram of the booth structure for design idea 23. The diagram shows various components labeled A, B, C, D, and E, which correspond to the parts list below.</p>	<p>A 3D rendering of the booth design for design idea 23, showing the final assembled look with the suspended sign and display walls.</p>
<p>A:LTFS-500*1000 -17 pieces B:LTFS-500*2000 -19 pieces C:LTFS-1000*1000 -7 pieces</p>	<p>D:LTFS-1000*2000 -7 pieces E:LTFS-1000*500 -4 pieces</p>

Frames	Design Cases
<p>A 3D exploded view diagram of the booth structure for design idea 24. The diagram shows various components labeled A, B, C, D, E, F, and G, which correspond to the parts list below.</p>	<p>A 3D rendering of the booth design for design idea 24, featuring a red and white color scheme with 'BUSINESS TECHNOLOGIES' branding.</p>
<p>A:LTFS-1000*1000 -11 pieces B:LTFS-2500*1000 -3 pieces C:LTFS-2000*1000 -2 pieces D:LTFS-2500*500 -4 pieces</p>	<p>E:LTFS-1000*500 -11 pieces F:LTFS-500*500 -5 pieces G:LTFS-500*2000 -1 piece</p>

Frames	Design Cases
<p>A 3D exploded view diagram of the booth structure for design idea 25. The diagram shows various components labeled A, B, and C, which correspond to the parts list below.</p>	<p>A 3D rendering of the booth design for design idea 25, featuring a blue and white color scheme with a large display wall.</p>
<p>A:LTFS-500*2500 -33 pieces B:LTFS-500*500 -22 pieces C:LTFS-1000*500 -2 pieces</p>	



LTFS80

REALISATIONS

